



ASI-O-095BAWWW10/M

No.	Items	Specification	Unit
1	Display Mode	Passive Matrix OLED	-
2	Display Color	Monochrome (White)	-
3	Duty	1/64	-
4	Resolution	96 (H) x 64 (V)	Pixel
5	Active Area	19.953 (W) x 13.424 (H)	mm
6	Outline Dimension	24.90 (W) x 22.95 (H) x 1.40 (D)	mm
7	Pixel Pitch	0.208 (W) x 0.210 (H)	mm
8	Pixel Size	0.193 (W) x 0.194 (H)	mm
9	Driver IC	SSD1305Z	-
10	Interface	8-bit parallel,4-wire SPI,I2C	-
11	Weight	1.65	g



CONTENT

- PHYSICAL DATA
- EXTERNAL DIMENSIONS
- ABSOLUTE MAXIMUM RATINGS
- ELECTRICAL CHARACTERISTICS
- TIMING OF POWER SUPPLY
- ELECTRO-OPTICAL CHARACTERISTICS
- INTERFACE PIN CONNECTIONS
- RELIABILITY TESTS
- OUTGOING QUALITY CONTROL SPECIFICATION
- CAUTIONS IN USING OLED MODULE

■ **PHYSICAL DATA**

No.	Items	Specification	Unit
1	Display Mode	Passive Matrix OLED	-
2	Display Color	Monochrome (White)	-
3	Duty	1/64	-
4	Resolution	96 (H) x 64 (V)	Pixel
5	Active Area	19.953 (W) x 13.424 (H)	mm
6	Outline Dimension	24.90 (W) x 22.95 (H) x 1.40 (D)	mm
7	Pixel Pitch	0.208 (W) x 0.210 (H)	mm
8	Pixel Size	0.193 (W) x 0.194 (H)	mm
9	Driver IC	SSD1305Z	-
10	Interface	8-bit parallel,4-wire SPI,I2C	-
11	Weight	1.65	g

EXTERNAL DIMENSIONS

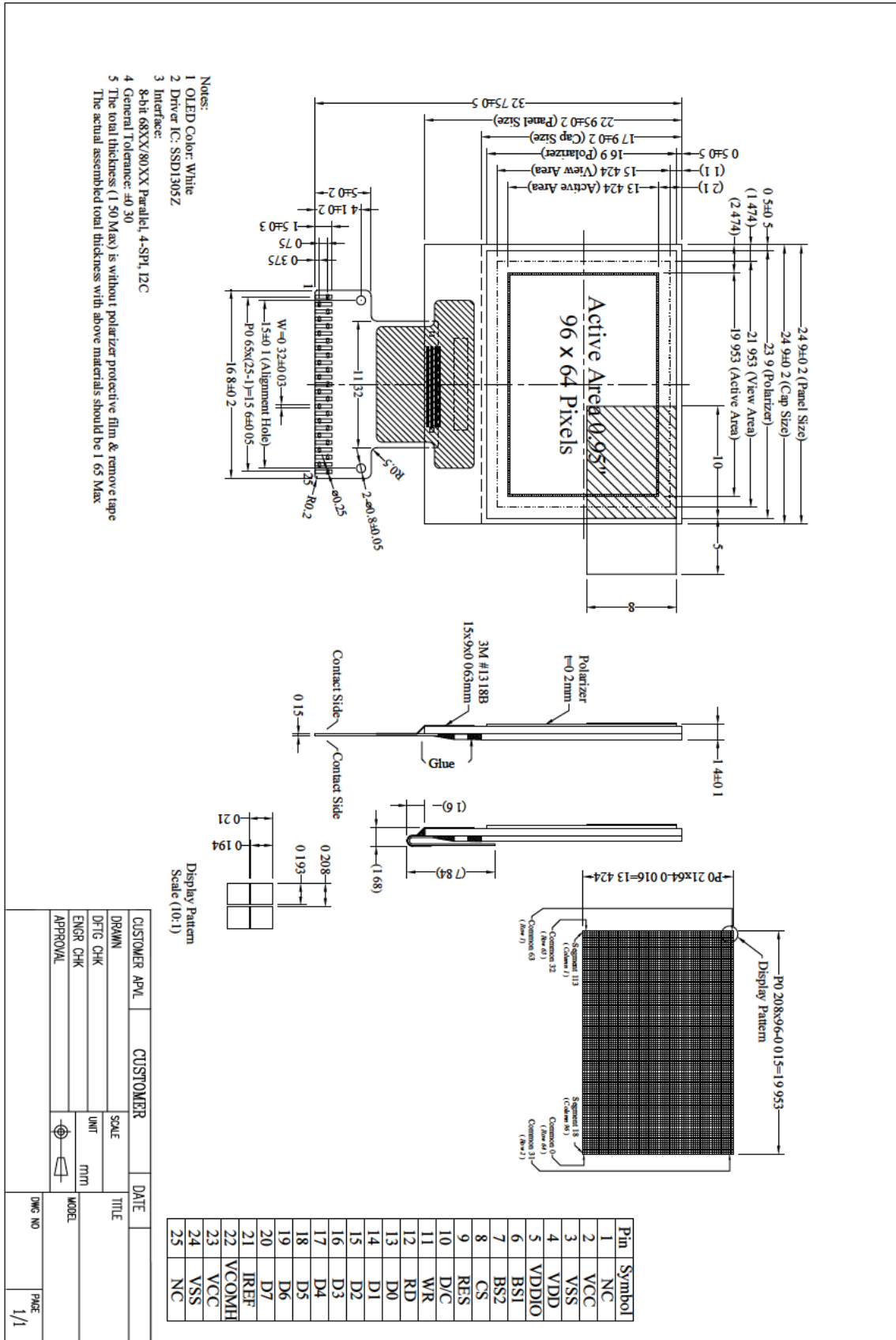

■ **ABSOLUTE MAXIMUM RATINGS**

Items	Symbol	Min	Typ.	Max	Unit	Notes
Supply voltage for logic	V _{DD}	-0.3	-	4	V	1,2
Supply voltage for I/O pins	V _{DDIO}	-0.3	-	V _{DD} +0.5	V	1,2
Driver supply voltage	V _{CC}	0	-	15.0	V	1,2
Operating temperature	T _{OP}	-30	-	70	°C	-
Storage temperature	T _{ST}	-40	-	85	°C	-
Life time(120cd/m ²)	-	30,000	-	-	hour	4
Humidity	-	-	-	90	%RH	-

Note 1: All the above voltages are on the basis of V_{SS} = 0V .

Note 2: When this module is used beyond the above absolute maximum ratings, permanent breakage of the module may occur. Also, for normal operations, it is desirable to use this module under the conditions according to electro-optical characteristics . If this module is used beyond these conditions, malfunctioning of the module can occur and the reliability of the module may deteriorate.

Note 3: V_{CC} = 11V, T_a = 25°C, 50% Checkerboard.

Software configuration follows Actual Application Example .

End of lifetime is specified as 50% of initial brightness reached. The average operating lifetime at room temperature is estimated by the accelerated operation at high temperature conditions.



■ ELECTRICAL CHARACTERISTICS

DC Characteristics

Items	Symbol	Conditions	Min	Typ.	Max	Unit
Supply voltage for logic	V_{DD}		2.6	2.8	3.5	V
Supply voltage for I/O pins	V_{DDIO}		1.6	2.8	V_{DD}	V
Supply voltage for display	V_{CC}		-	11	-	V
High level input	V_{IH}		$0.8V_{DDIO}$	-	V_{DDIO}	V
Low level input	V_{IL}		0	-	$0.2V_{DDIO}$	V
High level output	V_{OH}	$I_{OUT} = 100\mu A, 3.3MH$	$0.9V_{DDIO}$	-	V_{DDIO}	V
Low level output	V_{OL}	$I_{OUT} = 100\mu A, 3.3MH$	0	-	$0.1 V_{DDIO}$	V
Operating current for V_{DD} & V_{DDIO}	I_{DD} & $DDIO$	Note 4	-	0.1	0.5	mA
		Note 5	-	0.1	0.5	mA
Operating current for V_{CC}	I_{CC}	Note 4	-	5	6	mA
		Note 5	-	8	10	mA
Sleep mode current for V_{DD} & V_{DDIO}	I_{DD} & $DDIO$ SLEEP		-	1	5	μA
Sleep mode current for V_{CC}	$I_{CC,SLEEP}$		-	1	5	

Note 4: V_{DD} & $V_{DDIO} = 2.8V$, $V_{CC} = 11V$, Frame Rate = 140Hz, Contrast Setting = 0x40, 50% Display Area Turn on.

Note 5: V_{DD} & $V_{DDIO} = 2.8V$, $V_{CC} = 11V$, Frame Rate = 140Hz, Contrast Setting = 0x40, 100% Display Area Turn on.

◆ AC Characteristics

1. 80XX-Series MPU Parallel Interface Timing Characteristics:

Symbol	Description	Min	Max	Unit
t_{cycle}	System Cycle Time	300	-	ns
t_{AS}	Address Setup Time	0	-	ns
t_{AH}	Address Hold Time	0	-	ns
t_{DSW}	Write Data Setup Time	40	-	ns
t_{DHW}	Write Data Hold Time	7	-	ns
t_{DHR}	Read Data Hold Time	20	-	ns
t_{OH}	Output Disable Time	-	70	ns
t_{ACC}	Access Time	-	140	ns
PW_{CSL}	Chip Select Low Pulse Width (Read)	120	-	ns
	Chip Select Low pulse width (Write)	60		
PW_{CSH}	Chip Select High Pulse Width (Read)	60	-	ns
	Chip Select High Pulse Width (Write)	60		
t_R	Rise Time	-	15	ns
t_F	Fall Time	-	15	ns

* $V_{DD} \sim V_{SS} = 2.4$ to $3.5V$, $T_A = 25^\circ C$

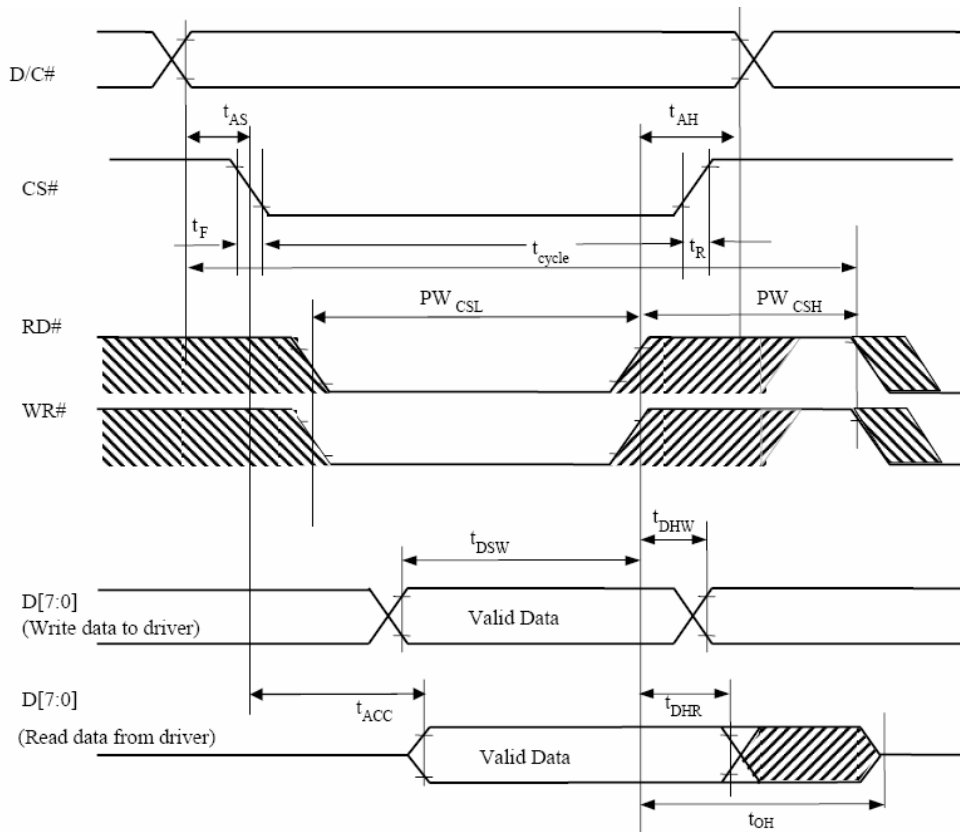

2. 68XX-Series MPU Parallel Interface Timing Characteristics:

Symbol	Description	Min	Max	Unit
t_{cycle}	System Cycle Time	300	-	ns
t_{AS}	Address Setup Time	0	-	ns
t_{AH}	Address Hold Time	0	-	ns
t_{DSW}	Write Data Setup Time	40	-	ns
t_{DHW}	Write Data Hold Time	7	-	ns
t_{DHR}	Read Data Hold Time	20	-	ns
t_{OH}	Output Disable Time	-	70	ns
t_{ACC}	Access Time	-	140	ns
PW_{CSL}	Chip Select Low Pulse Width (Read)	120	-	ns
	Chip Select Low pulse width (Write)	60		
PW_{CSH}	Chip Select High Pulse Width (Read)	60	-	ns
	Chip Select High Pulse Width (Write)	60		
t_R	Rise Time	-	15	ns
t_F	Fall Time	-	15	ns

* $V_{DD} - V_{SS} = 2.4$ to $3.5V$, $T_A = 25$

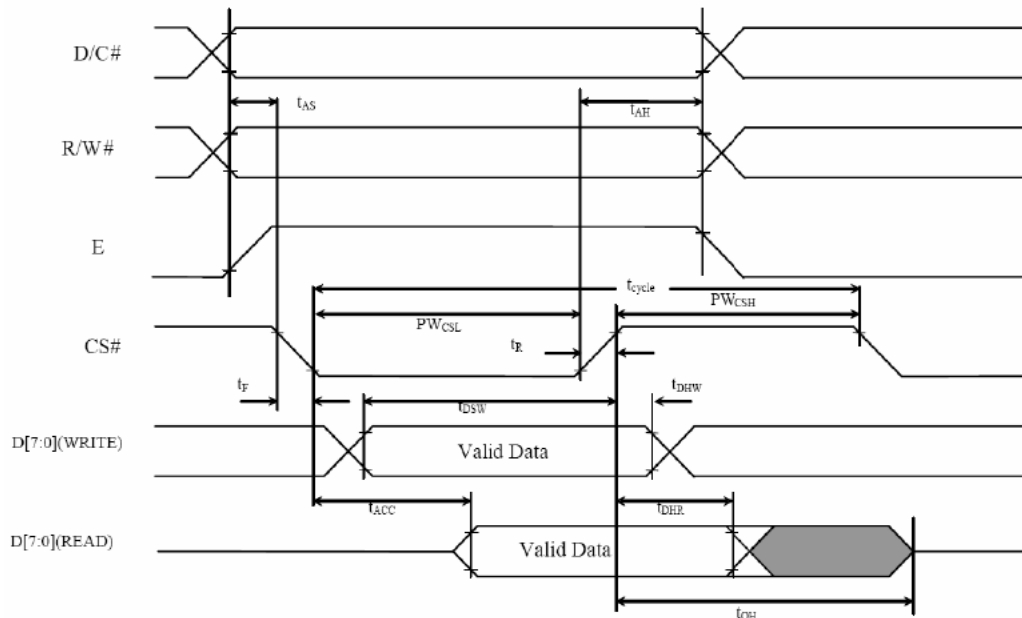

3. Serial Interface Timing Characteristics:

Symbol	Description	Min	Max	Unit
t_{cycle}	Clock Cycle Time	250	-	ns
t_{AS}	Address Setup Time	150	-	ns
t_{AH}	Address Hold Time	150	-	ns
t_{CSS}	Chip Select Setup Time	120	-	ns
t_{CSH}	Chip Select Hold Time	60	-	ns
t_{DSW}	Write Data Setup Time	50	-	ns
t_{DHW}	Write Data Hold Time	15	-	ns
t_{CLKH}	Serial Clock High Time	100	-	ns
t_{CLKL}	Serial Clock Low Time	100	-	ns
t_R	Rise Time	-	15	ns
t_F	Fall Time	-	15	ns

* $V_{DD} \sim V_{SS} = 2.4$ to $3.5V$, $T_A = 25^\circ C$

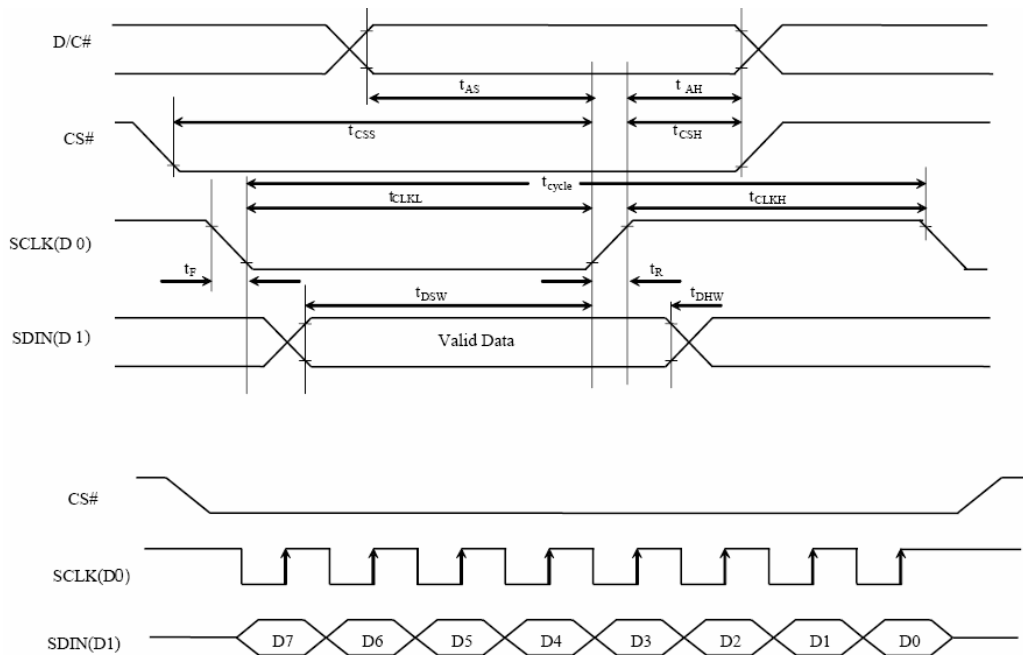

4. I²C Interface Timing Characteristics:

Symbol	Description	Min	Max	Unit
t _{cycle}	Clock Cycle Time	250	-	ns
t _{AS}	Address Setup Time	150	-	ns
t _{AH}	Address Hold Time	150	-	ns
t _{CSS}	Chip Select Setup Time	120	-	ns
t _{CSH}	Chip Select Hold Time	60	-	ns
t _{DSW}	Write Data Setup Time	50	-	ns
t _{DHW}	Write Data Hold Time	15	-	ns
t _{CLKH}	Serial Clock High Time	100	-	ns
t _{CLKL}	Serial Clock Low Time	100	-	ns
t _R	Rise Time	-	15	ns
t _F	Fall Time	-	15	ns

* VDD~VSS = 2.4 to 3.5V, TA=25

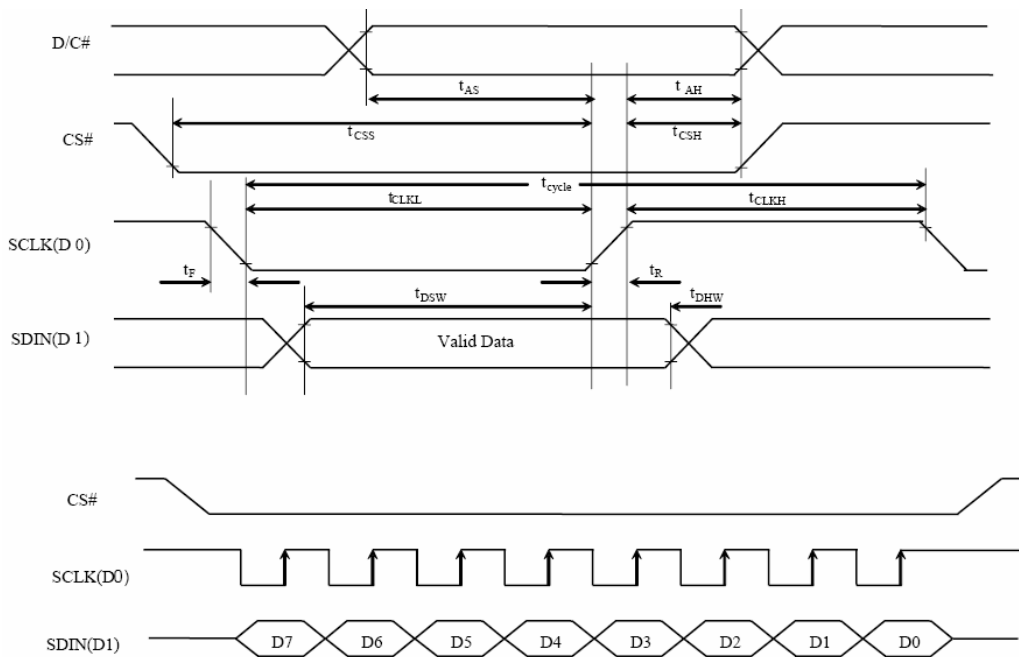

■ TIMING OF POWER SUPPLY

1. Commands

Refer to the Technical Manual for the SSD1305

2. Power down and Power up Sequence

To protect OEL panel and extend the panel life time, the driver IC power up/down routine should include a delay period between high voltage and low voltage power sources during turn on/off. It gives the OEL panel enough time to complete the action of charge and discharge before/after the operation.

2.1 Power up Sequence:

1. Power up V_{DD} & V_{DDIO}
2. Send Display off command
3. Clear Screen
4. Power up V_{CC}
5. Delay 100ms
(when V_{DD} & V_{DDIO} is stable)
6. Send Display on command

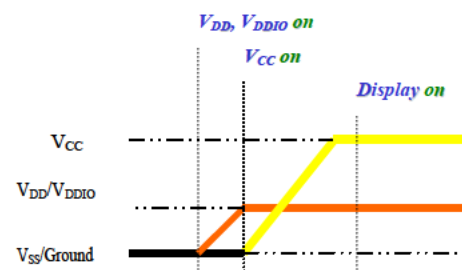

2.2 Power down Sequence:

1. Send Display off command
2. Power down V_{CC}
3. Delay 100ms
(when V_{CC} is reach 0 and panel is completely discharges)
4. Power down V_{DD} & V_{DDIO}

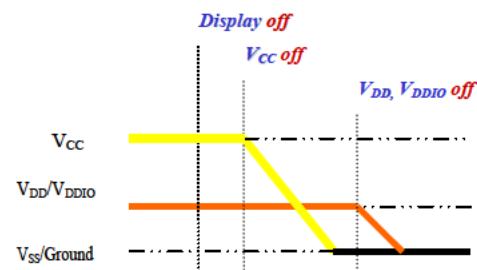

3. Reset Circuit

When RES# input is low, the chip is initialized with the following status:

1. Display is OFF
2. 96×64 Display Mode
3. Normal segment and display data column and row address mapping (SEG0 mapped to column address 00H and COM0 mapped to row address 00H)
4. Shift register data clear in serial interface
5. Display start line is set at display RAM address 0
6. Column address counter is set at 0
7. Normal scan direction of the COM outputs
8. Contrast control register is set at 80H
9. Normal display mode (Equivalent to A4h command)

4. Actual Application Example

Command usage and explanation of an actual example

<Initialization Setting>

Set Deactivate Scroll
(00101101)

Set Pre-charge Period
(11011001 with XXXXXXXX)

Set Contrast Control Register
(10000001 with XXXXXXXX)

Set Brightness for Color Banks
(10000010 with XXXXXXXX)

Set Look Up Table (LUT)
(10010001 with **XXXXXX, **XXXXXX, **XXXXXX, **XXXXXX)

Set Area Color Mode & Low Power Display Mode
(11011000 with 00XX0X0X)
00000101 => 0x05 (Mono & Low Power Save Mode)

Set Segment Re-map
(1010000X)

Set COM Output Scan Direction
(1100X000)

Set COM Pins Hardware Configuration
(11011010 with 00XX0010)
00010010 => 0x12 (Alternative Mode)

Set Display Start Line
(01XXXXXX)

Set Display Offset
(11010011 with **XXXXXX)

Set Multiplex Ratio
(10101000 with **XXXXXX)

Set Display Clock Divide Ratio / Oscillator Frequency
(11010101 with XXXXXXXX)

Set DC/DC On/Off
(10101101 with 1000101X)
10001010 => 0x8A (Off)

Set VCOMH Deselect Level
(11011011 with 0XXXXX00)

Set Entire Display On (1010010X)
10100100 => 0xA4 (Normal)

Set Normal/Inverse Display (1010011X)
10100110 => 0xA6 (Normal)

Set Display On/Off (1010111X)
10101111 => 0xAF (Turns On)



<Display Boundary Setting>

Set Memory Addressing Mode
(00100000 with *****XX)

<Page Addressing Mode Setting>

Set Page Start Address for Page Addressing Mode (10110XXX)
10110000 => 0xB0

Set Lower Column Address for Page Addressing Mode
(0000XXXX)

Set Higher Column Address for Page Addressing Mode
(0001XXXX)

<Horizontal or Vertical Addressing Mode Setting>

Set Column Address
(00100001 with XXXXXXXX, XXXXXXXX)

Set Page Address
(00100010 with *****XXX, *****XXX)

If the noise is accidentally occurred at the displaying window during the operation, please reset the display in order to recover the display function.

■ **ELECTRO-OPTICAL CHARACTERISTICS (Ta=25°C)**

Items	Symbol	Min.	Typ.	Max.	Unit	Remark	
Operating Luminance	L	60	80	-	cd /m ²	White	
Power Consumption	P	-	-	-	mW	30% pixels ON L=110cd/m ²	
Frame Frequency	Fr	-	-	-	Hz		
Color Coordinate	White	CIE x	0.28	0.32	0.36	CIE1931	Darkroom
		CIE y	0.29	0.33	0.37		
Response Time	Rise	Tr	-	-	-	ms	-
	Decay	Td	-	-	-	ms	-
Contrast Ratio*	Cr	100:1	-	-		Darkroom	
Viewing Angle Uniformity	$\Delta \theta$	160	-	-	Degree	-	

Note : Brightness (L_{br}) is subject to the change of the panel characteristics and the customer's request.

Note 6: Optical measurement taken at 1/64 duty, 140Hz Frame Rate, Contrast Setting = 0x40.

Software configuration follows Actual Application Example .

■ INTERFACE PIN CONNECTIONS

1. Block Diagram

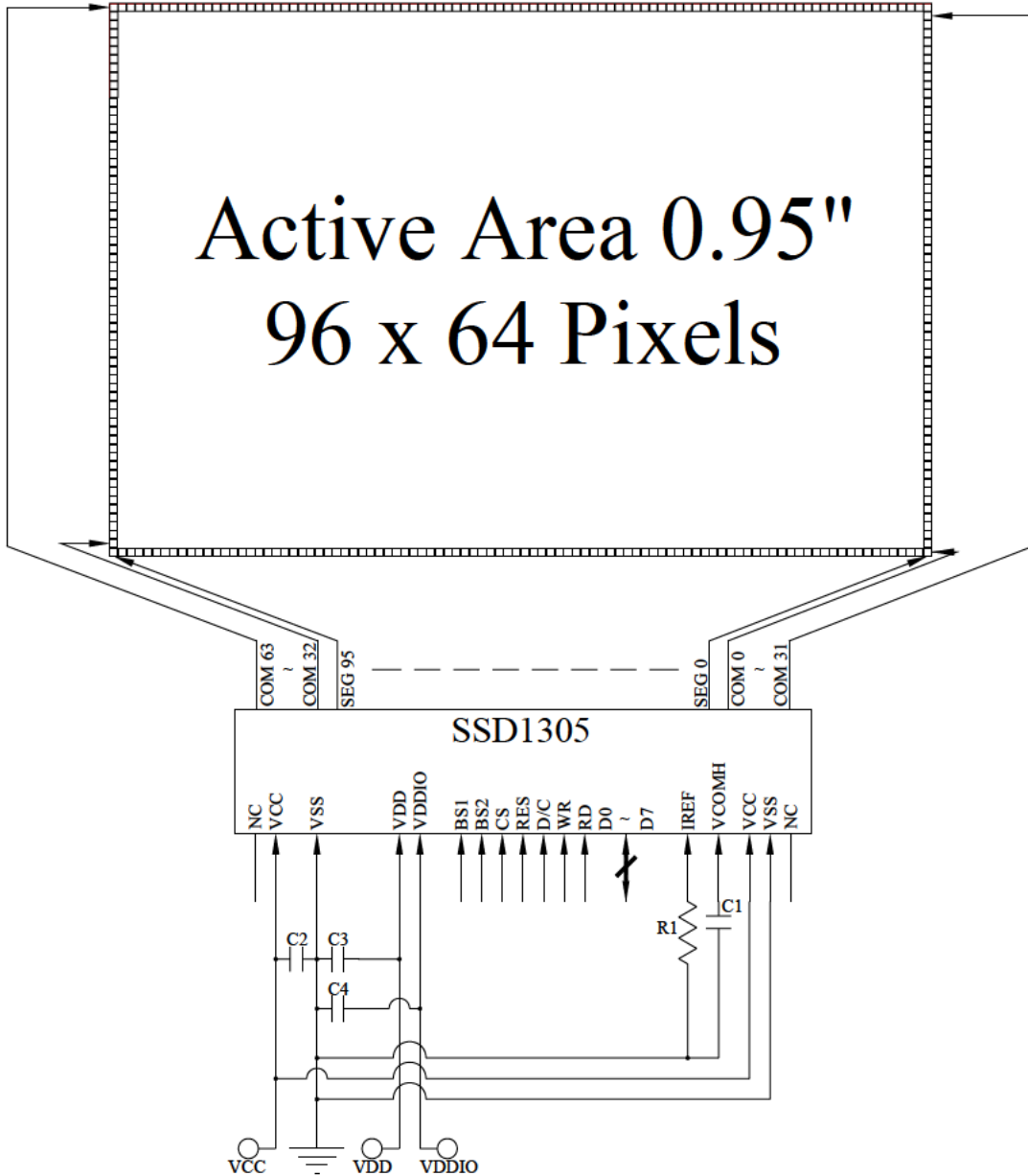

MCU Interface Selection: BS1 and BS2

Pins connected to MCU interface: D7~D0, RD, WR, D/C, RES, and CS

C1, C2, C3, C4: 4.7 μ F

R1: 910k Ω , $R1 = (\text{Voltage at IREF} - VSS) / IREF$



2. Pin Definition

Pin Number	Symbol	Type	Function
Power Supply Pins			
4	VDD	P	<i>Power Supply for Core Logic Operation</i> This is a voltage supply pin. It must be connected to external source.
5	VDDIO	P	<i>Power Supply for Interface Logic Level</i> This is a voltage supply pin. It should match with MCU interface voltage level. VDDIO must always be equal or lower than VDD.
3, 24	VSS	P	<i>Ground of OEL System</i> This is a ground pin. It also acts as a reference for the logic pins, the OEL driving voltages, and the analog circuits. It must be connected to external ground.
2, 23	VCC	P	<i>Power Supply for OEL Panel</i> This is the most positive voltage supply pin of the chip. It must be connected to external source.
MPU Interface Pins			
8	CS	I	<i>Chip Select</i> This pin is the chip select input. The chip is enabled for MCU communication only when CS# is pulled low.
9	RES	I	<i>Power Reset for Controller and Driver</i> This pin is reset signal input. When the pin is low, initialization of the chip is executed.
10	D/C	I	<i>Data/Command Control</i> This pin is Data/Command control pin. When the pin is pulled high, the input at D7~D0 is treated as display data. When the pin is pulled low, the input at D7~D0 will be transferred to the command register. For detail relationship to MCU interface signals, please refer to the Timing Characteristics Diagrams.
11	WR	I	<i>Read/Write Select or Write</i> This pin is MCU interface input. When interfacing to a 68XX-series microprocessor, this pin will be used as Read/Write (R/W#) selection input. Pull this pin to "High" for read mode and pull it to "Low" for write mode. When 80XX interface mode is selected, this pin will be the Write (WR#) input. Data write operation is initiated when this pin is pulled low and the CS# is pulled low.
12	RD	I	<i>Read/Write Enable or Read</i> This pin is MCU interface input. When interfacing to a 68XX-series microprocessor, this pin will be used as the Enable (E) signal. Read/write operation is initiated when this pin is pulled high and the CS# is pulled low. When connecting to an 80XX-microprocessor, this pin receives the Read (RD#) signal. Data read operation is initiated when this pin is pulled low and CS# is pulled low.
13~20	D0~D7	I/O	<i>Host Data Input/Output Bus</i> These pins are 8-bit bi-directional data bus to be connected to the microprocessor's data bus. When serial mode is selected, D1 will be the serial data input SDIN and D0 will be the serial clock input SCLK.



Pin Number	Symbol	Type	Function															
System Control Pins																		
21	IREF	I	<i>Current Reference for Brightness Adjustment</i> This pin is segment current reference pin. A resistor should be connected between this pin and VSS. Set the current at 10uA.															
22	VCOMH	O	<i>Voltage Output High Level for COM Signal</i> This pin is the input pin for the voltage output high level for COM signals. A capacitor should be connected between this pin and VSS.															
6 7	BS1 BS2	I	<p><i>Communicating Protocol Select</i> These pins are MCU interface selection input. See the following table:</p> <table border="1"> <thead> <tr> <th></th> <th>I²C</th> <th>6800-parallel</th> <th>8080-parallel</th> <th>Serial</th> </tr> </thead> <tbody> <tr> <td>BS1</td> <td>1</td> <td>0</td> <td>1</td> <td>0</td> </tr> <tr> <td>BS2</td> <td>0</td> <td>1</td> <td>1</td> <td>0</td> </tr> </tbody> </table> <p>Note: "0" is connected to V_{SS}; "1" is connected to V_{DDIO}.</p>		I ² C	6800-parallel	8080-parallel	Serial	BS1	1	0	1	0	BS2	0	1	1	0
	I ² C	6800-parallel	8080-parallel	Serial														
BS1	1	0	1	0														
BS2	0	1	1	0														
Reserved Pins																		
1, 25	NC	-	<i>No Connection</i>															

■ RELIABILITY TESTS

Item		Condition	Criterion
High Temperature Storage (HTS)		85±2°C, 240 hours	<ol style="list-style-type: none"> 1. After testing, the function test is ok. 2. After testing, no addition to the defect. 3. After testing, the change of luminance should be within +/- 50% of initial value. 4. After testing, the change for the mono and area color must be within (+/-0.02, +/-0.02) and for the full color it must be within (+/-0.04, +/-0.04) of initial value based on 1931 CIE coordinates. 5. After testing, the change of total current consumption should be within +/- 50% of initial value.
High Temperature Operating (HTO)		70±2°C, 240 hours	
Low Temperature Storage (LTS)		-40±2°C, 240 hours	
Low Temperature Operating (LTO)		-40±2°C, 240 hours	
High Temperature / High Humidity Storage (HTHHS)		60±3°C, 90%±3%RH, 120 hours	
Thermal Shock (Non-operation) (TS)		-40±2°C ~ 25°C ~ 85±2°C (30min) (5min) (30min) 24cycles	
Vibration (Packing)	10~55~10Hz, amplitude 1.5mm, 1 hour for each direction x, y, z	<ol style="list-style-type: none"> 1. One box for each test. 2. No addition to the cosmetic and the electrical defects. 	
Drop (Packing)	Height : 1 m, each time for 6 sides, 3 edges, 1 angle		

Note: 1) For each reliability test, the sample quantity is 3, and only for one test item.
 2) The HTHHS test is requested the Pure Water(Resistance > 10MΩ).

■ OUTGOING QUALITY CONTROL SPECIFICATION

◆ Standard

According to GB/T2828.1-2003/ISO 2859-1: 1999 and ANSI/ASQC Z1.4-1993, General Inspection Level II.

◆ Definition

- 1 Major defect : The defect that greatly affect the usability of product.
- 2 Minor defect : The other defects, such as cosmetic defects, etc.
- 3 Definition of inspection zone:

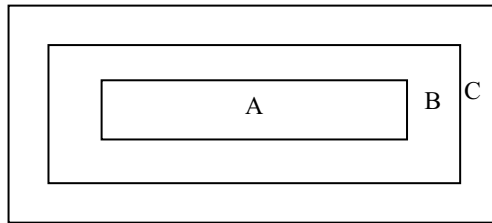

Zone A: Active Area

Zone B: Viewing Area except Zone A

Zone C: Outside Viewing Area

Note: As a general rule, visual defects in Zone C are permissible, when it is no trouble of quality and assembly to customer`s product.

◆ Inspection Methods

- 1 The general inspection : under 20W x 2 or 40W fluorescent light, about 30cm viewing distance, within 45° viewing angle, under 25±5°C.

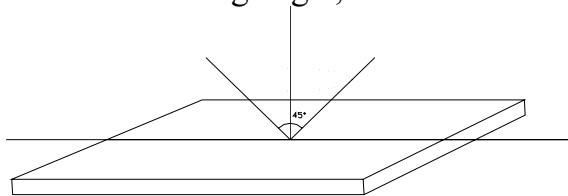

- 2 The luminance and color coordinate inspection : By PR705 or BM-7 or the equal equipments, in the dark room, under 25±5°C.

◆ Inspection Criteria

- 1 Major defect : AQL= 0.65

Item	Criterion
Function Defect	1. No display or abnormal display is not accepted
	2. Open or short is not accepted.
	3. Power consumption exceeding the spec is not accepted.
Outline Dimension	Outline dimension exceeding the spec is not accepted.
Glass Crack	Glass crack tends to enlarge is not accepted.

- 2 Minor Defect : AQL= 1.5

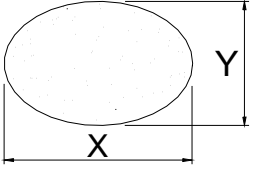
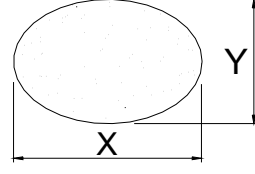
Item	Criterion			
Spot Defect (dimming and lighting spot)	Size (mm)		Accepted Qty	
			Area A + Area B	Area C
		$\Phi \leq 0.10$	Ignored	
		$0.10 < \Phi \leq 0.15$	3	Ignored
		$0.15 < \Phi \leq 0.20$	1	
$0.20 < \Phi$		0		
Note : $\Phi = (x + y) / 2$				
Line Defect (dimming and lighting line)	L (Length) : mm	W (Width) : mm	Area A + Area B	Area C
	/	$W \leq 0.03$	Ignored	
	$L \leq 3.0$	$0.03 < W \leq 0.05$	2	Ignored
	$L \leq 2.0$	$0.05 < W \leq 0.08$	1	
	/	$0.08 < W$	As spot defect	
Remarks: The total of spot defect and line defect shall not exceed 4 pcs.				
Polarizer Stain	Stain which can be wiped off lightly with a soft cloth or similar cleaning is accepted, otherwise, according to the Spot Defect and the Line Defect.			
Polarizer Scratch	1. If scratch can be seen during operation, according to the criterions of the Spot Defect and the Line Defect.			
	2. If scratch can be seen only under non-operation or some special angle, the criterion is as below :			
	L (Length) : mm	W (Width) : mm	Area A + Area B	Area C
	/	$W \leq 0.03$	Ignore	
	$5.0 < L \leq 10.0$	$0.03 < W \leq 0.05$	2	Ignore
	$L \leq 5.0$	$0.05 < W \leq 0.08$	1	
/	$0.08 < W$	0		
Polarizer Air Bubble	Size		Area A + Area B	Area C
		$\Phi \leq 0.20$	Ignored	
		$0.20 < \Phi \leq 0.50$	2	Ignored
		$0.50 < \Phi \leq 0.80$	1	
		$0.80 < \Phi$	0	

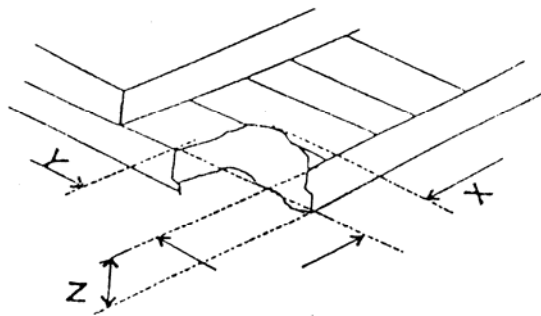
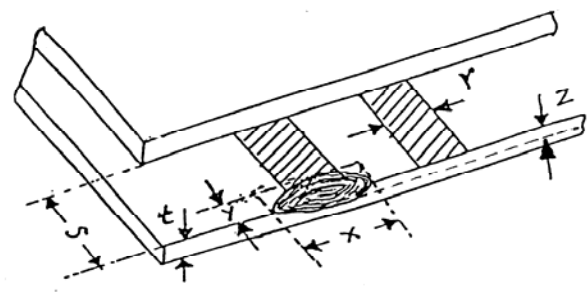
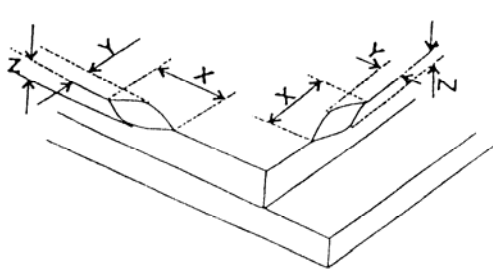
Glass Defect (Glass Chipped)	<p>1. On the corner</p>  <p style="text-align: right;">(mm)</p> <table border="1" style="margin-left: auto;"> <tr> <td>x</td> <td>≤ 2.0</td> </tr> <tr> <td>y</td> <td>$\leq S$</td> </tr> <tr> <td>z</td> <td>$\leq t$</td> </tr> </table>	x	≤ 2.0	y	$\leq S$	z	$\leq t$
	x	≤ 2.0					
	y	$\leq S$					
	z	$\leq t$					
<p>2. On the bonding edge</p>  <p style="text-align: right;">(mm)</p> <table border="1" style="margin-left: auto;"> <tr> <td>x</td> <td>$\leq a / 2$</td> </tr> <tr> <td>y</td> <td>$\leq s / 3$</td> </tr> <tr> <td>z</td> <td>$\leq t$</td> </tr> </table>	x	$\leq a / 2$	y	$\leq s / 3$	z	$\leq t$	
x	$\leq a / 2$						
y	$\leq s / 3$						
z	$\leq t$						
<p>3. On the other edges</p>  <p style="text-align: right;">(mm)</p> <table border="1" style="margin-left: auto;"> <tr> <td>x</td> <td>$\leq a / 5$</td> </tr> <tr> <td>y</td> <td>≤ 1.0</td> </tr> <tr> <td>z</td> <td>$\leq t$</td> </tr> </table>	x	$\leq a / 5$	y	≤ 1.0	z	$\leq t$	
x	$\leq a / 5$						
y	≤ 1.0						
z	$\leq t$						
<p>Note: t: glass thickness ; s: pad width ; a: the length of the edge</p>							
TCP Defect	Crack, deep fold and deep pressure mark on the TCP are not accepted						
Pixel Size	The tolerance of display pixel dimension should be within $\pm 20\%$ of the spec						
Luminance	Refer to the spec or the reference sample						
Color	Refer to the spec or the reference sample						

■ CAUTIONS IN USING OLED MODULE

◆ Precautions For Handling OLED Module:

1. OLED module consists of glass and polarizer. Pay attention to the following items when handling:
 - i. Avoid drop from high, avoid excessive impact and pressure.
 - ii. Do not touch, push or rub the exposed polarizers with anything harder than an HB pencil lead.
 - iii. If the surface becomes dirty, breathe on the surface and gently wipe it off with a soft dry cloth. If it is terrible dirty, moisten the soft cloth with Isopropyl alcohol or Ethyl alcohol. Other solvents may damage the polarizer. Especially water, Ketone and Aromatic solvents.
 - iv. Wipe off saliva or water drops immediately, contact the polarizer with water over a long period of time may cause deformation.
 - v. Please keep the temperature within specified range for use and storage. Polarization degradation, bubble generation or polarizer peeling-off may occur with high temperature and high humidity.
 - vi. Condensation on the surface and the terminals due to cold or anything will damage, stain or dirty the polarizer, so make it clean as the way of iii.
2. Do not attempt to disassemble or process the OLED Module.
3. Make sure the TCP or the FPC of the Module is free of twisting, warping and distortion, do not pull or bend them forcefully, especially the soldering pins. On the other side, the SLIT part of the TCP is made to bend in the necessary case.
4. When assembling the module into other equipment, give the glass enough space to avoid excessive pressure on the glass, especially the glass cover which is much more fragile.
5. Be sure to keep the air pressure under 120 kPa, otherwise the glass cover is to be cracked.
6. Be careful to prevent damage by static electricity:
 - i. Be sure to ground the body when handling the OLED Modules.
 - ii. All machines and tools required for assembling, such as soldering irons, must be properly grounded.
 - iii. Do not assemble and do no other work under dry conditions to reduce the amount of static electricity generated. A relative humidity of 50%-60% is recommended.
 - iv. Peel off the protective film slowly to avoid the amount of static electricity generated.
 - v. Avoid to touch the circuit, the soldering pins and the IC on the Module by the body.
 - vi. Be sure to use anti-static package.
7. Contamination on terminals can cause an electrochemical reaction and corrode the terminal circuit, so make it clean anytime.
8. All terminals should be open, do not attach any conductor or semiconductor on the terminals.
9. When the logic circuit power is off, do not apply the input signals.
10. Power on sequence: $V_{DD} \rightarrow V_{PP}$, and power off sequence: $V_{PP} \rightarrow V_{DD}$.
11. Be sure to keep temperature, humidity and voltage within the ranges of the spec, otherwise shorten Module's life time, even make it damaged.
12. Be sure to drive the OLED Module following the Specification and Datasheet of IC controller, otherwise something wrong may be seen.

13. When displaying images, keep them rolling, and avoid one fixed image displaying more than 30 seconds, otherwise the residue image is to be seen. This is the speciality of OLED.

◆ **Precautions For Soldering OLED Module:**

1. Soldering temperature : $260^{\circ}\text{C} \pm 10^{\circ}\text{C}$.
2. Soldering time : 3-4 sec.
3. Repeating time : no more than 3 times.
4. If soldering flux is used, be sure to remove any remaining flux after finishing soldering operation. (This does not apply in the case of a non-halogen type of flux.) It is recommended to protect the surface with a cover during soldering to prevent any damage due to flux spatters.

◆ **Precautions For Storing OLED Module:**

1. Be sure to store the OLED Module in the vacuum bag with dessicant.
2. If the Module can not be used up in 1 month after the bag being opened, make sure to seal the Module in the vacuum bag with dessicant again.
3. Store the Module in a dark place, do not expose to sunlight or fluorescent light.
4. The polarizer surface should not touch any other objects. It is recommended to store the Module in the shipping container.
5. It is recommended to keep the temperature between 0°C and 30°C , the relative humidity not over 60%.

◆ **Limited Warranty**

Unless relevant quality agreements signed with customer and law enforcement, for a period of 12 months from date of production, all products (except automotive products) All Shore will replace or repair any of its OLED modules which are found to be functional defect when inspected in accordance with All Shore OLED acceptance standards (copies available upon request). Cosmetic/visual defects must be returned to All Shore within 90 days of shipment. Confirmation of such date should be based on freight documents. The warranty liability of All Shore is limited to repair and/or replacement on the terms above. All Shore will not be responsible for any subsequent or consequential events.

◆ **Return OLED Module Under Warranty:**

1. No warranty in the case that the precautions are disregarded.
2. Module repairs will be invoiced to the customer upon mutual agreement. Modules must be returned with sufficient description of the failures or defects.